

CHICAGO[®]

Electric

DIGITAL SOLDERING STATION

Model 96531

SET UP AND OPERATING INSTRUCTIONS

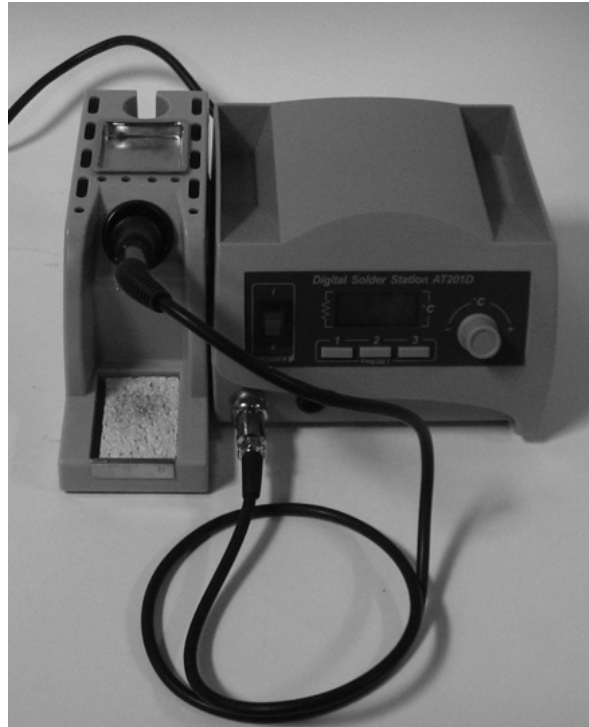

Diagrams within this manual may not be drawn proportionally.
Due to continuing improvements, actual product may differ slightly from the product described herein.

Distributed Exclusively by Harbor Freight Tools
3491 Mission Oaks Blvd., Camarillo, CA 93011
Visit our website at: <http://www.harborfreight.com>



**Read this material before using this product.
Failure to do so can result in serious injury.
SAVE THIS MANUAL.**

Copyright© 2007 by Harbor Freight Tools[®]. All rights reserved. No portion of this manual or any artwork contained herein may be reproduced in any shape or form without the express written consent of Harbor Freight Tools.

For technical questions or replacement parts, please call 1-800-444-3353.

CONTENTS

IMPORTANT SAFETY INFORMATION	3
GENERAL SAFETY RULES	3
Work Area	4
Electrical Safety	4
Personal Safety	4
Tool Use and Care.....	5
Service	6
SPECIFIC SAFETY RULES	6
GROUNDING	6
Grounded Tools: Tools with Three Prong Plugs	7
Double Insulated Tools: Tools with Two Prong Plugs.....	7
Extension Cords	7
Symbology.....	8
SPECIFICATIONS.....	9
UNPACKING	9
ASSEMBLY	9
OPERATION.....	10
MAINTENANCE, AND SERVICING.....	12
PARTS LIST	14
ASSEMBLY DIAGRAM.....	14
WARRANTY	15

SAVE THIS MANUAL

Keep this manual for the safety warnings and precautions, assembly, operating, inspection, maintenance and cleaning procedures. Write the product's serial number in the back of the manual near the assembly diagram (or month and year of purchase if product has no number). Keep this manual and the receipt in a safe and dry place for future reference.

IMPORTANT SAFETY INFORMATION

In this manual, on the labeling, and all other information provided with this product:



This is the safety alert symbol. It is used to alert you to potential personal injury hazards. Obey all safety messages that follow this symbol to avoid possible injury or death.

 **DANGER**

DANGER indicates a hazardous situation which, if not avoided, will result in death or serious injury.

 **WARNING**

WARNING indicates a hazardous situation which, if not avoided, could result in death or serious injury.

 **CAUTION**

CAUTION, used with the safety alert symbol, indicates a hazardous situation which, if not avoided, could result in minor or moderate injury.

NOTICE

NOTICE is used to address practices not related to personal injury.

CAUTION

CAUTION, without the safety alert symbol, is used to address practices not related to personal injury.

GENERAL SAFETY RULES



WARNING! Read all instructions

Failure to follow all instructions listed below may result in electric shock, fire, and/or serious injury. The term “power tool” in all of the warnings listed below refers to your mains-operated (corded) power tool or battery-operated (cordless) power tool.

SAVE THESE INSTRUCTIONS

1. **Work area safety**

- a. Keep work area clean and well lit. *Cluttered or dark areas invite accidents.*
- b. Do not operate power tools in explosive atmospheres, such as in the presence of flammable liquids, gases or dust. *The intense heat from the Soldering Station may ignite the dust or fumes.*
- c. Operate this power tool only in a well-ventilated area. Be extremely careful not to breathe vapors from any solder, especially ones containing lead. Lead is a heavy metal which can accumulate in the body and cause serious health problems.
- d. **Keep children and bystanders away while operating a power tool. Distractions can cause you to lose control.**

2. **Electrical safety**

- a. Power tool plugs must match the outlet. Never modify the plug in any way. Do not use any adapter plugs with earthed (grounded) power tools. *Unmodified plugs and matching outlets will reduce risk of electric shock.*
- b. Avoid body contact with earthed or grounded surfaces such as pipes, radiators, ranges and refrigerators. *There is an increased risk of electric shock if your body is earthed or grounded.*
- c. **Do not expose power tools to rain or wet conditions. Water entering a power tool will increase the risk of electric shock.**
- d. **Do not abuse the cord. Never use the cord for carrying, pulling or unplugging the power tool. Keep cord away from heat, oil, sharp edges or moving parts. Damaged or entangled cords increase the risk of electric shock.**
- e. Never operate this power tool outdoors.

3. **Personal safety**

- a. Stay alert, watch what you are doing and use common sense when operating a power tool. Do not use a power tool while you are tired or under the influence of drugs, alcohol or medication. *A moment of inattention while operating power tools may result in serious personal injury.*

- b. **Use safety equipment. Always wear eye protection. *Safety equipment such as dust mask, non-skid safety shoes, heavy-duty work gloves, hard hat, or hearing protection used for appropriate conditions will reduce personal injuries.***
 - c. Avoid accidental starting. Ensure the switch is in the off-position before plugging in. *Carrying power tools with your finger on the switch or plugging in power tools that have the switch on invites accidents.*
 - d. Do not overreach. Keep proper footing and balance at all times. *This enables better control of the power tool in unexpected situations.*
 - e. Dress properly. Do not wear loose clothing or jewelry. Keep your hair, clothing and gloves away from moving parts. *Loose clothes, jewelry or long hair can be caught in moving parts.*
4. **Power tool use and care**
- a. Do not force the power tool. Use the correct power tool for your application. *The correct power tool will do the job better and safer at the rate for which it was designed.*
 - b. Do not use the power tool if the switch does not turn it on and off. *Any power tool that cannot be controlled with the switch is dangerous and must be repaired.*
 - c. **Disconnect the plug from the power source and from the power tool before making any adjustments, changing accessories, or storing power tools. *Such preventive safety measures reduce the risk of starting the power tool accidentally.***
 - d. **Store idle power tools out of the reach of children and do not allow persons unfamiliar with the power tool or these instructions to operate the power tool. *Power tools are dangerous in the hands of untrained users.***
 - e. Maintain power tools. Check for misalignment or binding of moving parts, breakage of parts and any other condition that may affect the power tools operation. If damaged, have the power tool repaired before use. *Many accidents are caused by poorly maintained power tools.*
 - f. Use the power tool, accessories and tool bits etc., in accordance with these instructions and in the manner intended for the particular type of power tool, taking into account the working conditions and the work to be performed. *Use of the power tool for operations different from those intended could result in a hazardous situation.*
5. **Service**
- a. Have your power tool serviced by a qualified repair person using only identical replacement parts. *This will ensure that the safety of the power tool is maintained.*

SPECIFIC SAFETY RULES

1. Maintain labels and nameplates on the tool. These carry important safety information. If unreadable or missing, contact Harbor Freight Tools for a replacement.
2. Avoid unintentional starting. Prepare to begin work before turning on the tool.
3. Do not leave the tool unattended when it is plugged into an electrical outlet. Turn off the tool, and unplug it from its electrical outlet before leaving. Make sure soldering wire is not connected to tool that is plugged in.
4. Use clamps (not included) or other practical ways to secure and support the workpiece to a stable platform. Holding the work by hand or against your body is unstable and may lead to loss of control.
5. Use in well-ventilated area only and keep out of reach of children.
6. People with pacemakers should consult their physician(s) before use. Electro-magnetic fields in close proximity to heart pacemaker could cause pacemaker interference or pacemaker failure.
7. **WARNING:** This product, when used for welding, plasma cutting, soldering, or similar applications, produces chemicals known to the State of California to cause cancer and birth defects (or other reproductive harm). (California Health & Safety Code § 25249.5, *et seq.*)
8. Use caution when handling the Soldering Tip; it comes to a sharp point and is especially dangerous when heated. The soldering tip can generate temperatures up to 896°F, always use caution when working with this tool and keep flammable items at a clear, safe distance.
9. The warnings, precautions, and instructions discussed in this instruction manual cannot cover all possible conditions and situations that may occur. It must be understood by the operator that common sense and caution are factors which cannot be built into this product, but must be supplied by the operator.



SAVE THESE INSTRUCTIONS.

GROUNDING

! WARNING

Improperly connecting grounding wire can result in electric shock.



Check with qualified electrician if you are in doubt as to whether outlet is properly grounded. Do not modify power cord plug provided with the tool. Never remove grounding prong from the plug. Do not use tool if power cord or plug is damaged. If damaged, have it repaired by a service facility

before use. If the plug will not fit the outlet, have a proper outlet installed by a qualified electrician.

Grounded Tools: Tools with Three Prong Plugs

1. Tools marked with “Grounding Required” have a three wire cord and three prong grounding plug. The plug must be connected to a properly grounded outlet. If the tool should electrically malfunction or break down, grounding provides a low resistance path to carry electricity away from the user, reducing the risk of electric shock. **(See 3-Prong Plug and Outlet.)**
2. The grounding prong in the plug is connected through the green wire inside the cord to the grounding system in the tool. The green wire in the cord must be the only wire connected to the tool’s grounding system and must never be attached to an electrically “live” terminal. **(See 3-Prong Plug and Outlet.)**
3. The tool must be plugged into an appropriate outlet, properly installed and grounded in accordance with all codes and ordinances. The plug and outlet should look like those in the following illustration. **(See 3-Prong Plug and Outlet.)**

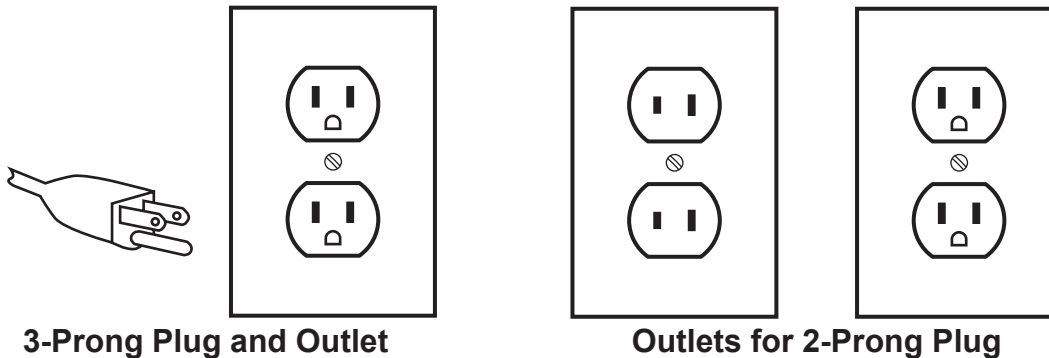

3-Prong Plug and Outlet

Outlets for 2-Prong Plug

Double Insulated Tools: Tools with Two Prong Plugs

1. Tools marked “Double Insulated” do not require grounding. They have a special double insulation system which satisfies OSHA requirements and complies with the applicable standards of Underwriters Laboratories, Inc., the Canadian Standard Association, and the National Electrical Code. **(See Outlets for 2-Prong Plug.)**
2. Double insulated tools may be used in either of the 120 volt outlets shown in the preceding illustration. **(See Outlets for 2-Prong Plug.)**

Extension Cords



1. **Grounded** tools require a three wire extension cord. **Double Insulated** tools can use either a two or three wire extension cord.

2. As the distance from the supply outlet increases, you must use a heavier gauge extension cord. Using extension cords with inadequately sized wire causes a serious drop in voltage, resulting in loss of power and possible tool damage. **(See Table A.)**
3. The smaller the gauge number of the wire, the greater the capacity of the cord. For example, a 14 gauge cord can carry a higher current than a 16 gauge cord. **(See Table A.)**
4. When using more than one extension cord to make up the total length, make sure each cord contains at least the minimum wire size required. **(See Table A.)**
5. If you are using one extension cord for more than one tool, add the nameplate amperes and use the sum to determine the required minimum cord size. **(See Table A.)**
6. If you are using an extension cord outdoors, make sure it is marked with the suffix “W-A” (“W” in Canada) to indicate it is acceptable for outdoor use.
7. Make sure the extension cord is properly wired and in good electrical condition. Always replace a damaged extension cord or have it repaired by a qualified electrician before using it.
8. Protect the extension cords from sharp objects, excessive heat, and damp or wet areas.

RECOMMENDED MINIMUM WIRE GAUGE FOR EXTENSION CORDS* (120/240 VOLT)					
NAMEPLATE AMPERES (at full load)	EXTENSION CORD LENGTH				
	25 Feet	50 Feet	75 Feet	100 Feet	150 Feet
0 – 2.0	18	18	18	18	16
2.1 – 3.4	18	18	18	16	14
3.5 – 5.0	18	18	16	14	12
5.1 – 7.0	18	16	14	12	12
7.1 – 12.0	18	14	12	10	-
12.1 – 16.0	14	12	10	-	-
16.1 – 20.0	12	10	-	-	-

TABLE A * Based on limiting the line voltage drop to five volts at 150% of the rated amperes.

Symbology

	Double Insulated	V~	Volts Alternating Current
	Canadian Standards Association	A	Amperes
	Underwriters Laboratories, Inc.	n_0 xxxx/min.	No Load Revolutions per Minute (RPM)

SPECIFICATIONS

Electrical Requirements	120 V~ / 60 Hz, .5 Amps
Power Consumption	60 Watt
Temperature Range	150°~450°C, 300°~840°F
Power Cord	18 AWG X 3C
Fuse	6.3A/250V
Weight	5.1 Pounds

UNPACKING

When unpacking, check to make sure that the item is intact and undamaged. If any parts are missing or broken, please call Harbor Freight Tools at the number shown on the cover of this manual as soon as possible.

List of contents

Description	Qty
Soldering Station	1
Soldering Handle Assembly	1
Soldering Iron Stand	1

SET UP INSTRUCTIONS



Read the **ENTIRE IMPORTANT SAFETY INFORMATION** section at the beginning of this manual including all text under subheadings therein before set up or use of this product.

WARNING

Risk of accidental starting; resulting in serious personal injury. Turn the Power Switch of the tool to its “OFF” position and unplug the tool from its electrical outlet before assembling or making any adjustments to the tool.

Note: For additional information regarding the parts listed in the following pages, refer to the Assembly Diagram near the end of this manual.

Assembly

1. Match up holes in Plug (27) to pins in Cord Connection (6), plug in, and secure with Cord Retainer (26).
2. Place Sponge in the bottom of the handle rest unit.
3. Set up handle rest unit within easy reach of the Soldering Station.
4. Plug Soldering Station into any standard, 120V AC electrical outlet.

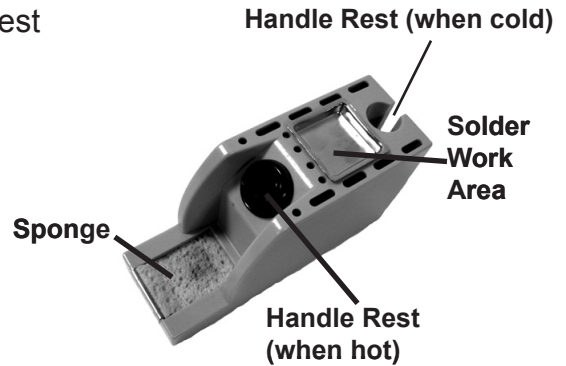

Functions

The Digital Soldering Station is designed to heat solder in order to secure wiring and metal surfaces together.

OPERATING INSTRUCTIONS



Read the **ENTIRE IMPORTANT SAFETY INFORMATION** section at the beginning of this manual including all text under subheadings therein before set up or use of this product.

Tool set up

1. Check for breakage, worn parts, damaged cords, or any other condition that may effect the tool's operation. If damaged, have the tool serviced by a qualified technician before using.
2. Tighten the Tip Retainer (16) on the Soldering Iron (15).
3. Select the correct solder for the intended application. Read the directions for the solder being used to determine what temperature level to set on the Soldering Station. To minimize the risk of damage to surrounding components, select the minimum heat required to melt the solder chosen for the application.
4. Plug Soldering Station in and turn Power Switch (4) to the "ON" position. Turn the Temperature Dial (8) and wait until the desired temperature is displayed on the LCD Display (5) or push one of the Preset Buttons.
 - Preset Button 1 = 150°C (302°F)
 - Preset Button 2 = 270°C (518°F)
 - Preset Button 3 = 360°C (680°F)

5. Place Handle in the Handle Rest (black socket) and wait 20 seconds until Soldering Tip heats up.

Work piece set up

1. If wires are to be soldered, thoroughly clean and scrape the wires so that only the clean copper is showing. Splice wires that are to be soldered together.
2. If other metals are to be soldered, thoroughly clean and scrape the metal surfaces. It may be necessary to apply acid flux (not included) to clean the metal surfaces before soldering.
3. If soldering on printed circuit boards, too much heat can soften the plastic form or loosen the metal eyelet connections. Use the lowest heat setting possible (see the solder's directions) to perform the soldering operation. **Never use acid core solder or acid flux on wiring circuits.**
4. Place tip of Soldering Iron (15) **under** the joint which you are soldering.
5. If uncertain on how to proceed, it may be wise to practice on a scrap workpiece first.

General operating instructions

1. When operating, use only in designated soldering work area.
2. Apply solder to the joint, wiring, or metal to be soldered, not to the Soldering Tip. When the metal is hot enough, it will melt the solder and allow it to flow around the wiring or metal being soldered. Slowly move Soldering Tip around to coat the entire area being soldered.
3. When the entire wiring or metal surface is encased in solder, remove the Soldering Tip and place in the handle rest.
4. Allow the soldering to cool completely before pulling gently on the item to ensure a secure hold. Blowing air on the soldered joint will help speed up the cooling.
5. When you are finished soldering, wipe the Soldering Tip thoroughly on the Sponge and apply a small amount of rosin-core solder to coat the Soldering Tip and keep it clean.

Soldering Tips

1. The soldering process bonds two metal objects together using a metallic bonding material (solder) which has a lower melting point than the items being joined. Soldering is not appropriate for non-metallic objects such as plastic or wood.

2. Check to be sure the objects being joined will not be damaged by the heat of soldering. This tool generates a temperature up to 896°F. Test a scrap piece or inconspicuous area of your work piece with the soldering tip before proceeding.
3. Be sure the surfaces being soldered are clean before beginning. If necessary, use a soldering flux (not included) for cleaning. Apply the flux to the parts being joined, and heat the parts until the flux burns away.
4. Heat the parts being joined with the soldering tool, not the solder. Once the parts being joined are sufficiently heated, touch the solder to the work pieces. The solder will melt and adhere to the work pieces. Remove the soldering tip from the work pieces, and hold the pieces together until they have cooled enough for the solder to solidify.
5. Solder will “follow the heat”. Once a workpiece is sufficiently hot to melt the solder, the solder can be dragged along the workpiece by moving the soldering tip. The solder will follow the heat. This technique is helpful when soldering joints, such as a tube in a coupling. By applying solder to the edge of the coupling and then moving the soldering tip away from the edge, solder can be dragged into a concealed joint as it follows the heat.

WARNING: Some solders contain lead and some do not. Be extremely careful not to breathe vapors from any solder, especially ones containing lead. Lead is a heavy metal which can accumulate in the body and cause serious health problems. Remember to use in a well-ventilated work area and wear ANSI-approved safety goggles, heavy-duty work gloves, and a dust mask/respirator during use.

6. Solder is available in various types. Some solders have a flux core and some do not. Flux core solders contain flux and reduce the need to clean the work pieces before joining. Solid core solders do not contain flux, and require careful cleaning of the work material, and application of flux for additional cleaning.
7. Solder is available in various melting points. The heat range of solder may be expressed in temperature, or may be expressed as “easy,” “medium” or “hard”. “Easy” solder will melt before “medium”, “medium” will melt before “hard”, and “hard” will melt at only the highest temperatures. When making several solder joints on a single workpiece, you may use a mix of solder temperatures.

Note: The Anti-Static Ground on the unit is not utilized when the Soldering Station is equipped with a 3-prong plug.

MAINTENANCE AND SERVICING

WARNING

Risk of serious personal injury from accidental starting or electric shock. Turn the Power Switch of the tool to its “OFF” position, as marked with an “O” below the Power Switch

(4), and unplug the tool from its electrical outlet before performing inspection, maintenance, or cleaning procedures.

Damaged equipment can fail, causing personal injury. Do not use damaged equipment. If abnormal noise or vibration occurs, have the problem corrected before further use.

Cleaning, maintenance, and lubrication

1. **BEFORE EACH USE**, inspect the general condition of the tool. Check for damaged Soldering Iron (15) tip, loose screws, cracked or broken parts, damaged electrical wiring, and any other condition that may affect its safe operation.
2. **AFTER USE**, clean external surfaces and Soldering Tip.
3. **WARNING! If the supply cord of this power tool is damaged, it must be replaced only by a qualified service technician.**

Replacing the Soldering Iron

1. If Soldering Tip cracks or becomes eroded it must be replaced. The Soldering Tip cannot heat up properly when cracked or eroded.

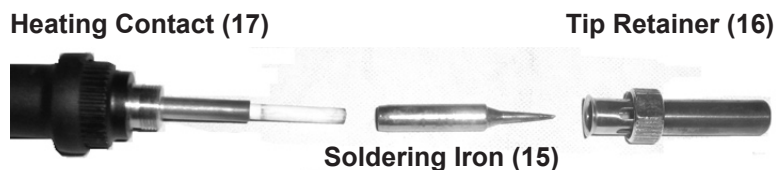

2. Turn Power Switch (4) to the “OFF” position and unplug the Soldering Station from the electrical outlet. Allow adequate time for all surfaces to cool down.
3. Unscrew Tip Retainer (16) that holds the Soldering Iron (15) onto the Heating Contact (17) and remove the Soldering Iron. It may be necessary to force the Soldering Iron (15) out of the Tip Retainer (16). To do this, place the Soldering Iron on the side of the work bench, hold the Tip Retainer, and push on it towards the Soldering Tip, forcing it out. Be sure to wear ANSI-approved safety goggles and heavy-duty work gloves while doing this.
4. Place new Solder Tip on Heating Contact, replace Retainer, and finger-tighten.

Replacing the Fuse

1. Turn the Power Switch (4) to the “OFF” position, unplug the Soldering Station from the outlet, and allow time for all surfaces of the unit to cool down completely.
2. Turn the Soldering Station over and use a screwdriver to remove the cover marked “FUSE” on the bottom.
3. Remove the old fuse and replace with a new 6.3A/250V fuse of the same type. Replace cover and screw back into place.

PARTS LIST & ASSEMBLY DIAGRAM

Part	Description	Qty
1	Upper Cover	1
2	Base	1
3	Panel	1
4	Power Switch	1
5	LCD Display	1
6	Cord Connection	1
7	Anti-Static	1
8	Temperature Dial	1
9	Cushion	1
10	Power Wire Group	1
11	Transformer	1
12	PCB Board	1
13	Radiator	1
14	Screw Sleeve	1
15	Soldering Iron	1
16	Tip Retainer	1
17	Heating Contact	1
18	Heat Wire Group	1
19	Grounding Spring	1
20	PCB Board	1
21	Handle	1
22	Handle Sleeve	1
23	Handle Tip Sleeve	1
24	Fastener	1
25	Cord	1
26	Cord Retainer	1
27	Plug	1

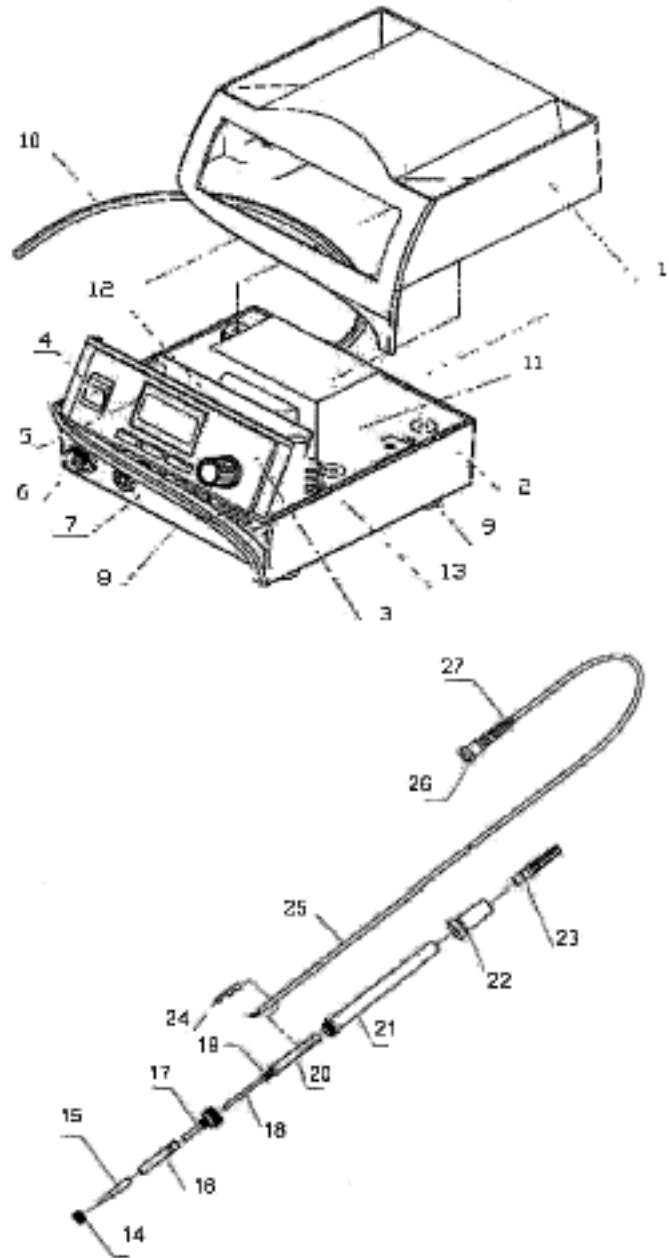

PLEASE READ THE FOLLOWING CAREFULLY

THE MANUFACTURER AND/OR DISTRIBUTOR HAS PROVIDED THE PARTS LIST AND ASSEMBLY DIAGRAM IN THIS MANUAL AS A REFERENCE TOOL ONLY. NEITHER THE MANUFACTURER OR DISTRIBUTOR MAKES ANY REPRESENTATION OR WARRANTY OF ANY KIND TO THE BUYER THAT HE OR SHE IS QUALIFIED TO MAKE ANY REPAIRS TO THE PRODUCT, OR THAT HE OR SHE IS QUALIFIED TO REPLACE ANY PARTS OF THE PRODUCT. IN FACT, THE MANUFACTURER AND/OR DISTRIBUTOR EXPRESSLY STATES THAT ALL REPAIRS AND PARTS REPLACEMENTS SHOULD BE UNDERTAKEN BY CERTIFIED AND LICENSED TECHNICIANS, AND NOT BY THE BUYER. THE BUYER ASSUMES ALL RISK AND LIABILITY ARISING OUT OF HIS OR HER REPAIRS TO THE ORIGINAL PRODUCT OR REPLACEMENT PARTS THERETO, OR ARISING OUT OF HIS OR HER INSTALLATION OF REPLACEMENT PARTS THERETO.

LIMITED 90 DAY WARRANTY

Harbor Freight Tools Co. makes every effort to assure that its products meet high quality and durability standards, and warrants to the original purchaser that this product is free from defects in materials and workmanship for the period of 90 days from the date of purchase. This warranty does not apply to damage due directly or indirectly, to misuse, abuse, negligence or accidents, repairs or alterations outside our facilities, criminal activity, improper installation, normal wear and tear, or to lack of maintenance. We shall in no event be liable for death, injuries to persons or property, or for incidental, contingent, special or consequential damages arising from the use of our product. Some states do not allow the exclusion or limitation of incidental or consequential damages, so the above limitation of exclusion may not apply to you. THIS WARRANTY IS EXPRESSLY IN LIEU OF ALL OTHER WARRANTIES, EXPRESS OR IMPLIED, INCLUDING THE WARRANTIES OF MERCHANTABILITY AND FITNESS.

To take advantage of this warranty, the product or part must be returned to us with transportation charges prepaid. Proof of purchase date and an explanation of the complaint must accompany the merchandise. If our inspection verifies the defect, we will either repair or replace the product at our election or we may elect to refund the purchase price if we cannot readily and quickly provide you with a replacement. We will return repaired products at our expense, but if we determine there is no defect, or that the defect resulted from causes not within the scope of our warranty, then you must bear the cost of returning the product.

This warranty gives you specific legal rights and you may also have other rights which vary from state to state.

3491 Mission Oaks Blvd. • PO Box 6009 • Camarillo, CA 93011 • (800) 444-3353

Record Product's Serial Number Here: _____

Note: If product has no serial number, record month and year of purchase instead.

Note: Some parts are listed and shown for illustration purposes only, and are not available individually as replacement parts.